

技术参数 Specifications

电气参数 Ratings:

- ◇ 额定工作电压
Rated Operational Voltage: 690V
- ◇ 额定工作电流
Rated Current: 6, 9, 12A
- ◇ 额定绝缘电压
Rated Insulation Voltage: 690V
- ◇ 额定冲击耐受电压
Rated Impulse Voltage: 6kV
- ◇ 额定接通能力
Rated Making Capacity: 10×Ie (AC-3) , 12×Ie (AC-4)
- ◇ 额定分断能力
Rated Breaking Capacity: 8×Ie (AC-3) , 10×Ie (AC-4)
- ◇ 极数
Number of Poles: 3P, 4P



认证/标准 Approvals/Standard:

- ◇ UL
- ◇ SEMKO
- ◇ CB
- ◇ CCC/CE

产品特征 Features&Benefits:







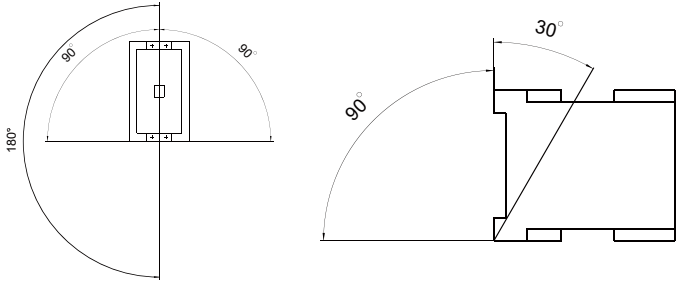

- 模块化设计, 产品结构紧凑
Modular design, compact product structure
- 操作性能安全可靠
Safe and reliable operation performance
- 特殊的触点工艺确保可靠的接触
Special contact technology ensures reliable contact
- 安装方便, 无需工具安装附件
Convenient installation without tools to install and remove accessories
- 更好的抗冲击性和抗震性能
Better impact resistance and seismic performance
- 防尘性能好, 可选配防尘配件
Dustproof performance, optional dustproof accessories can be added
- 低功耗线圈
Low power consumption coil

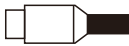
产品型号说明 Product Model:

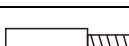
公司代码 Company Code	HC6	-06	M	10	/22	/N	220V	50/60Hz
额定电流 Rated Current	06=6A 09=9A 12=12A							
接触器类型 Contactor Type	M: Mini 接触器 Contactor							
辅助触头类型 Auxiliary Contact Type	10: 1常开 NO (仅迷你接触器 Only Mini Contactor) 01: 1常闭 NC (仅迷你接触器 Only Mini Contactor)							
主触头类型 Main Contact Type	22: 2常开 NO+2常闭 NC (仅迷你4P接触器 Only Mini 4P Contactor) 40: 4常开 NO (仅迷你4P接触器 Only Mini 4P Contactor)							
特殊功能 Special Function	N: 可逆接触器 Reversing Contactor Nil: 非可逆接触器 Non Reversing Contactor							
控制回路电压 Control Circuit Voltage	24V 36V 42V 48V 110V 120V 127V 208V 220V 230V 240V 277V 380V 400V 415V 440V 480V 500V 600V							
频率 Frequency	50Hz (不包括线圈电压为208/277/480/600V Except that the coil voltage are 208/277/480/600V) 50/60Hz							

特性参数 CHARACTERISTIC PARAMETERS						
产品型号 Product Model			HC6-06M	HC6-09M	HC6-12M	
约定自由空气发热电流 Conventional Free Air Thermal Current (Ith)	≤140°F (≤60°C)	A	20			
极数 Poles			3, 4			
额定绝缘电压 Rated Insulation Voltage (Ui)	V		690			
额定冲击耐受电压 Rated Impulse Voltage (Uimp)	kV		6			
额定接通能力 Rated Making Capacity			接通电流 Marking Current: 10×Ie (AC-3), 12×Ie (AC-4)			
额定分断能力 Rated Breaking Capacity			分断电流 Breaking Current: 8×Ie (AC-3), 10×Ie (AC-4)			
电气寿命 Electrical Durability ×10 ⁴	AC-3	Ops	120			
	AC-4	Ops	见特性曲线图 See the Characteristic Curves			
操作频率 Operation Frequency	AC-3	Ops/h	1200			
	AC-4	Ops/h	300			
机械寿命 Mechanical Durability ×10 ⁴	Ops		1500			
操作频率 Operation Frequency	Ops/h		3600			
相匹配的熔断器 Matching Fuse Type			NT00-20			
相匹配的热过载继电器 Matching Overload Relay Type			HCR6-12M			
自带辅助触头数量 Auxiliary Contact Composition			1常开或1常闭 1 NO or 1 NC			
环境温度 Ambient Temperature			-13~ +140°F (-25~ +60°C)			
安装位置 Installation Position						
外壳防护等级 Protection Degree			IP20			
抗冲击能力 Impact Resistance 1/2正弦波 Sine Wave =11ms	打开 Open	g	10			
	闭合 Close	g	15			
抗震能力 Seismic Performance	打开 Open	g	2			
	闭合 Close	g	4			
重量 Weight	g		185			
AC-1						
额定工作电流 Rated Operational Current (Ie)	≤104°F (≤40°C)	A	20	20	20	
	≤140°F (≤60°C)	A	20	20	20	
额定工作功率 Rated Operational Power (Pe)	220/240V	kW	8	8	8	
	380/415V	kW	14	14	14	
	500V	kW	17	17	17	
	660/690V	kW	22	22	22	
AC-3						
额定工作电流 Rated Operational Current (Ie)	220/240V	A	7	9	12	
	380/415V	A	6	9	12	
	500V	A	5	6	7	
	660/690V	A	4	5	5	
额定工作功率 Rated Operational Power (Pe)	220/240V	kW	1.5	2.2	3	
	380/415V	kW	2.2	4	5.5	
	500V	kW	3	4	5	
	660/690V	kW	3	4	5	
AC-4						
额定工作电流 Rated Operational Current (Ie)	380/415V	A	6	9	9	
	660/690V	A	3.8	5	5	
额定工作功率 Rated Operational Power (Pe)	380/415V	kW	3.2	4	4	
	660/690V	kW	3	4	4	
AC-4(200000寿命周期的额定功率和额定电流 Rated power and rated current for 200000 life cycles)						
额定工作电流 Rated Operational Current (Ie)	380/415V	A	2.7	4.5	4.5	
	660/690V	A	2.1	2.8	2.8	
额定工作功率 Rated Operational Power (Pe)	380/415V	kW	1.5	2.2	2.2	
	660/690V	kW	1.2	2.2	2.2	

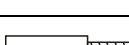
特性参数 CHARACTERISTIC PARAMETERS

产品型号 Product Model		HC6-06M	HC6-09M	HC6-12M		
UL						
电机额定功率 Rated Power of Motor 50/60Hz	1P	110-120V	HP	1/2	1/2	3/4
		220-240V	HP	1	1-1/2	2
	3P	200-208V	HP	1-1/2	2	3
		220-240V	HP	1-1/2	2	3
		440-480V	HP	3	5	7-1/2
550-600V	HP	3	5	7-1/2		
控制回路特性 Control Circuit Characteristic						
控制回路电压 Control Circuit Voltage		V	50Hz:24/36/42/48/110/120/127/220/230/240/380/400/415/440/500V 50/60Hz:24/36/42/48/110/120/127/208/220/230/240/277/380/400/ 415/440/480/500/600V			
电压范围 Voltage Range		吸合 Pick-up 释放 Drop-out	(75%-120%) Us (20%-65%) Us			
平均功耗 Average Power Consumption 50/60Hz	50Hz	吸合 Pick-up	VA	70		
		保持 Sealing	VA	7		
	60Hz	吸合 Pick-up	VA	70		
		保持 Sealing	VA	7.5		
平均功耗 Average Power Consumption 50Hz	50Hz	吸合 Pick-up	VA	70		
		保持 Sealing	VA	7		
动作时间 Operating Time	闭合延时 Closing Delay	ms	10-20			
	打开延时 Open Delay	ms	4-18			
热耗散 Current Heat Loss		交流 AC	W	1-3		
接线能力 Connections						
主回路 Main Circuit		1根 Piece	mm ²	1-2.5	1-2.5	1-2.5
		2根 Pieces	mm ²	1-1.5	1-1.5	1-1.5
		1根 Piece	mm ²	1-2.5	1-2.5	1-2.5
		2根 Pieces	mm ²	1-2.5	1-2.5	1-2.5
		1根 Piece	mm ²	1-2.5	1-2.5	1-2.5
		2根 Pieces	mm ²	1-2.5	1-2.5	1-2.5
		I	mm	3.6	3.6	3.6
		L	mm	7.5	7.5	7.5
	硬线/绞合 Solid/Stranded		AWG	18-14		
	连接螺钉/螺栓 Screw/Bolt		mm	M3.5		
扭矩 Tightening Torque		N·m	1.2			
控制回路 Control Circuit		1根 Piece	mm ²	1-2.5	1-2.5	1-2.5
		2根 Pieces	mm ²	1-1.5	1-1.5	1-1.5
		1根 Piece	mm ²	1-2.5	1-2.5	1-2.5
		2根 Pieces	mm ²	1-2.5	1-2.5	1-2.5
		1根 Piece	mm ²	1-2.5	1-2.5	1-2.5
		2根 Pieces	mm ²	1-2.5	1-2.5	1-2.5
		I	mm	3.6	3.6	3.6
		L	mm	7.5	7.5	7.5
	硬线/绞合 Solid/Stranded		AWG	18-14		
	连接螺钉/螺栓 Screw/Bolt		mm	M3.5		
扭矩 Tightening Torque		N·m	1.2			

外形及安装尺寸 Outline and Installations mm [inch]:

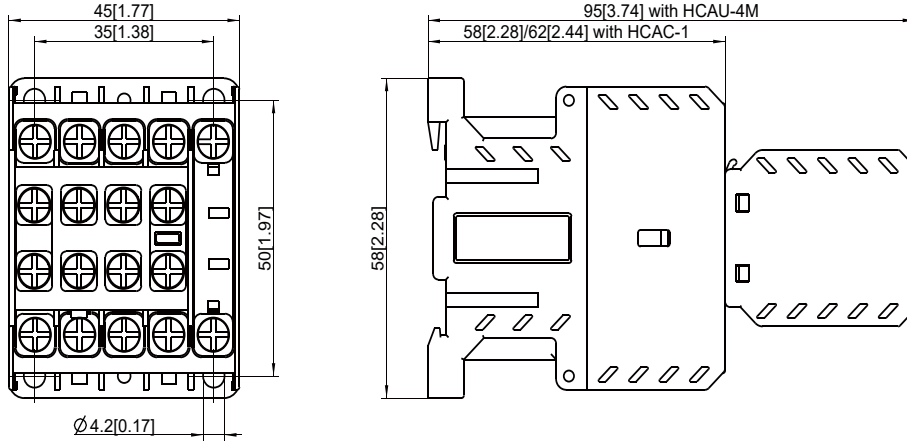

可逆接触器 Reversible contactor:

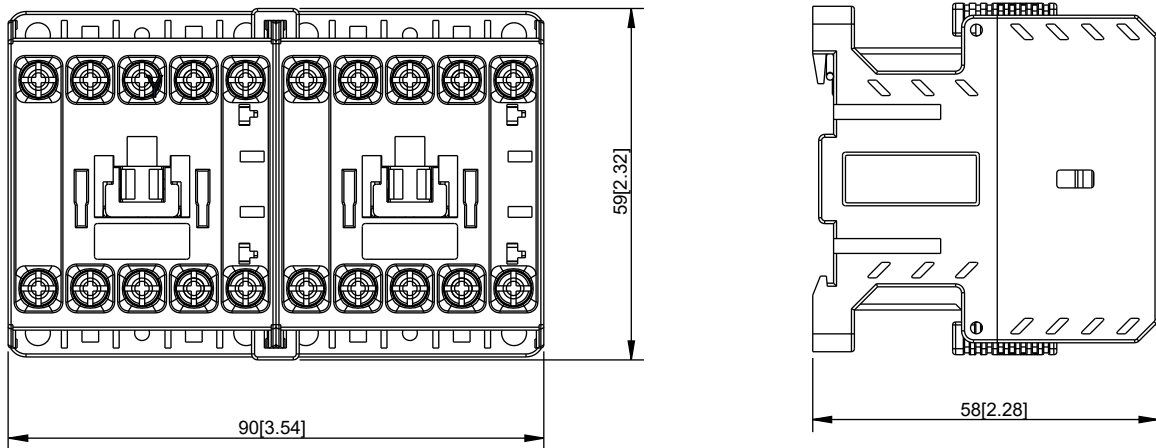

寿命曲线 Life curve:

